

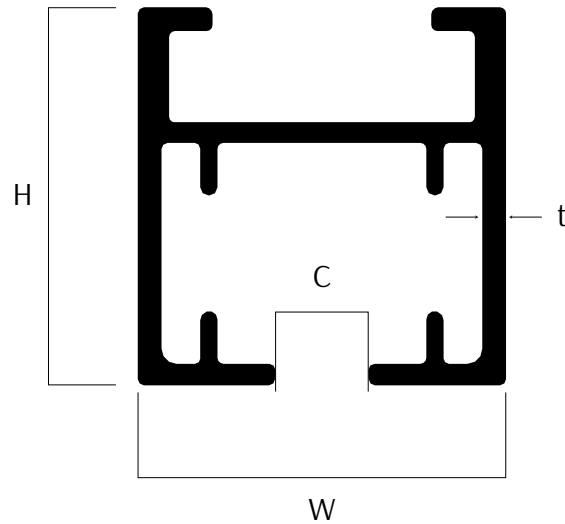

## DPFH Heavy Track - Window Curtain Track Specifications

Designed for heavy-duty applications, the Heavy Track is a robust solution for hanging heavyweight curtains. Whether it's for residential or commercial use, the Heavy Track is the ideal choice for those seeking a reliable and durable solution for their curtain hanging needs.



(All Dimensions are in millimeter.)

Length	W	H	C	T
4.58m/15ft.	24.35	25.00	6.20	1.50

### Summary of Profile

---

**Dimensions:** 24.35mm(W) x 25.00mm(H)

**Material:** Aluminium Alloy - 6063-T6 (HE9WP)

**Length:** 4.58m/15ft.

**Weight:** 0.421kg/m

**Tensile Strength:** 215MPA

**Color:** Signal White, Glossy Ivory, Brown, Light Gray, Black

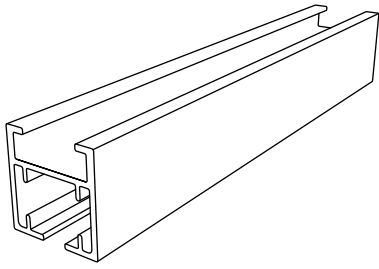

**Heavy Track Channel (H001)**  
Aluminium Extruded, Powder Coated,  
Heavy Duty Channel to Carry Heavyweight Curtains.

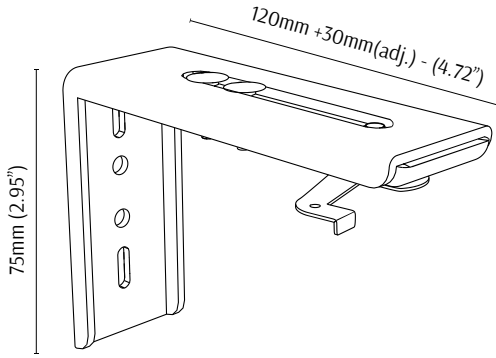

**Heavy Track Wall Mount (H002)**  
Adjustable Heavy-Duty Single Wall Mounting Bracket to Carry Heavyweight  
Curtain of any Type or Style.

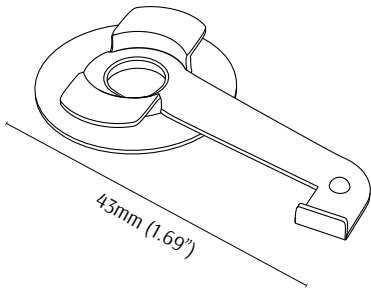

**Heavy Track Ceiling Mount (H003)**  
MS, Powder Coated, Swivel Bracket for Ceiling installations.

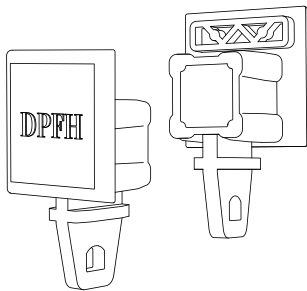

**Heavy Track "Screw-less" End Caps (H004)**  
In POM Material, DPFH Screw-Less Push System End-Cap Available for  
Quick Installation.

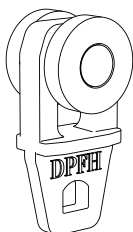

**Heavy Track Standard Runner (H005)**  
In POM Material, Highly-Durable and Smooth, Curtain Track Runner  
for Pleat type Curtains.

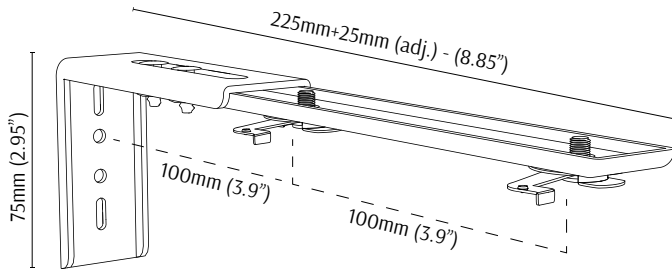

### Heavy Track 2-Track Holder for Pleat Curtains (H006)

MS, Powder Coated, Heavy-duty Adjustable,  
Double Track Wall Mount to Carry Two Heavyweight  
and/or Medium-Weight Curtains Simultaneously.

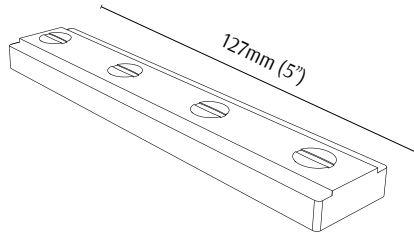

### Heavy Track Joints (H008)

Join Two Separate Curtain Tracks Together to  
Create One Long Piece.